

MINIMA®

FORMES MINIMA POCKET

MINIMA POCKET SHAPES
FORMAS MINIMA POCKET
MINIMA POCKET FORMEN
FORMAS MINIMA POCKET

POCKET

Pont traditionnel
Traditional bridge

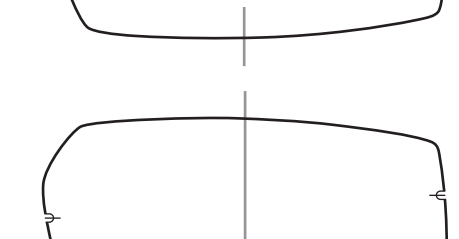
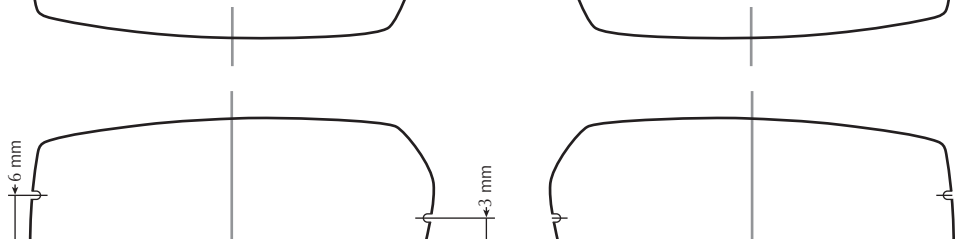
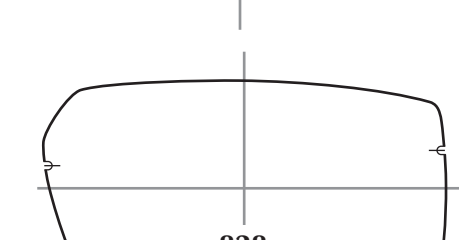
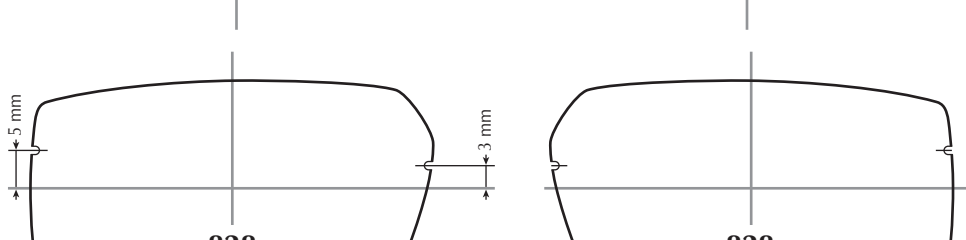
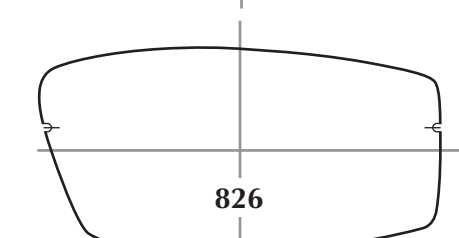
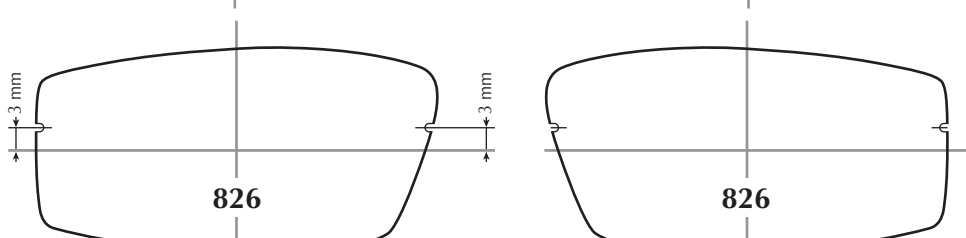
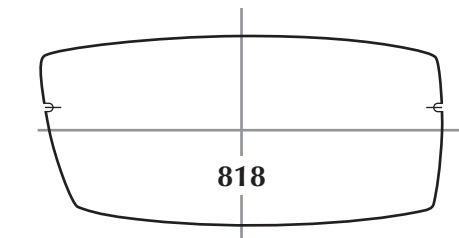
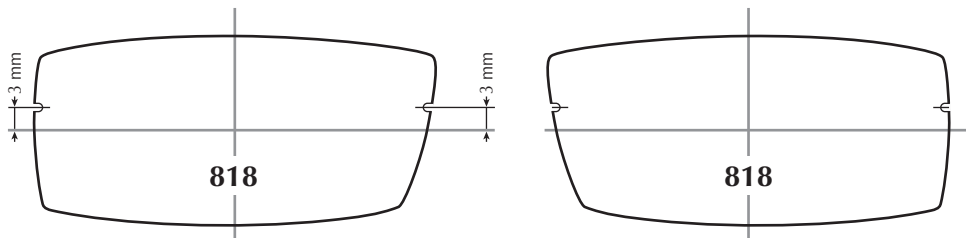
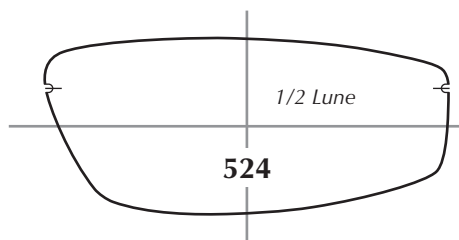
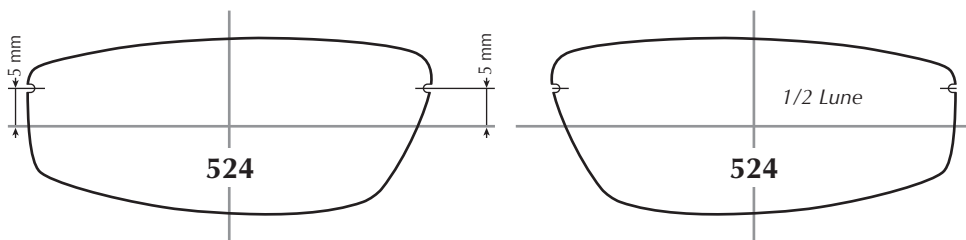
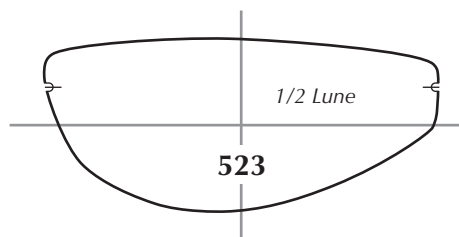
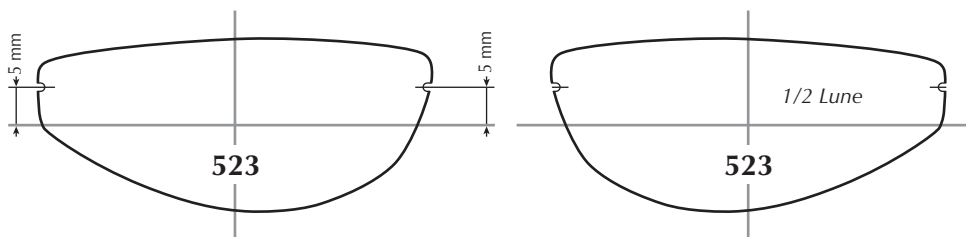
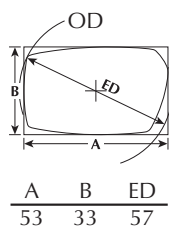
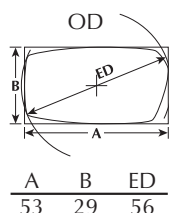
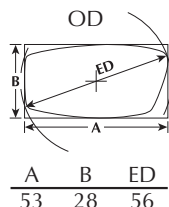
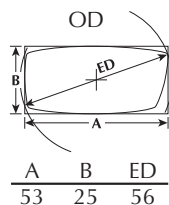
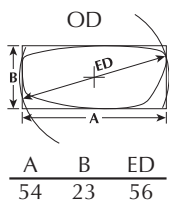
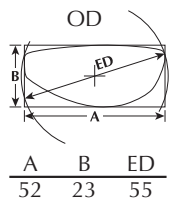

Toutes ces informations sont communiquées à titre indicatif et doivent être adaptées à la forme du nez du porteur.
All infos provided must be adapted to shape and size of the patient's nose.

⚠ Attention : certaines imprimantes peuvent ne pas reproduire ce document à l'échelle exacte.
Note: some printers may not duplicate this document at the correct scale.

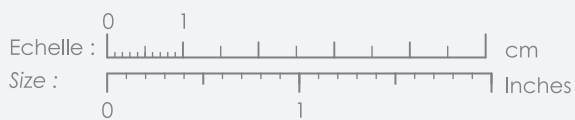

POCKET

Pont traditionnel
Traditional bridge

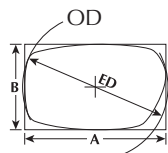

A	B	ED
52	32	54

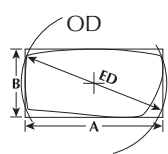
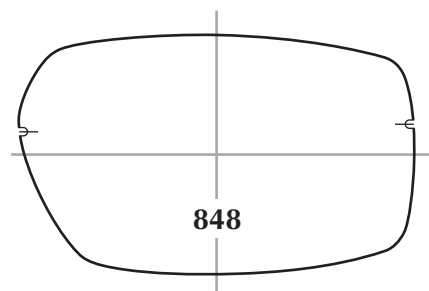
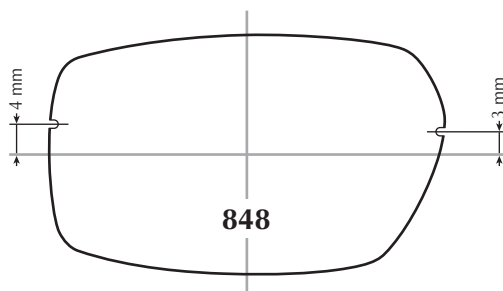

A	B	ED
51	25	54

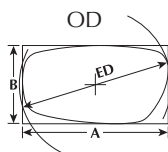
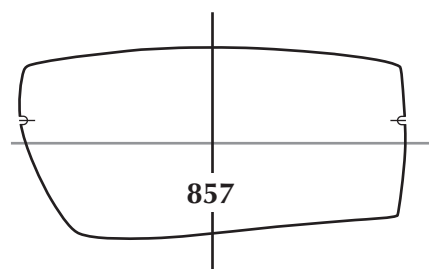
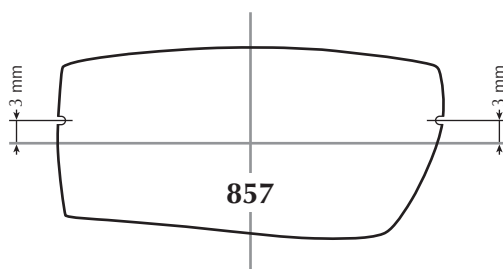

A	B	ED
54	29	56

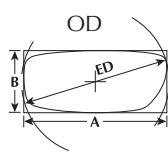
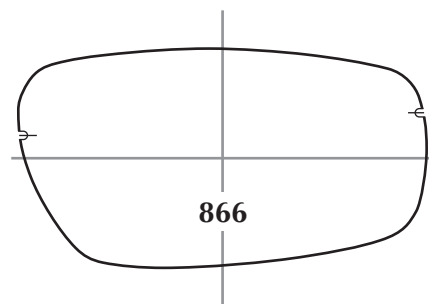
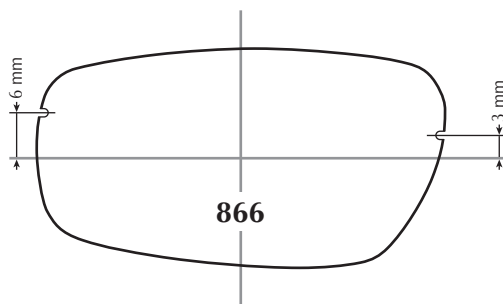

A	B	ED
53	23	55

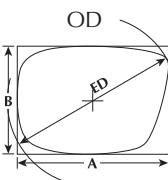
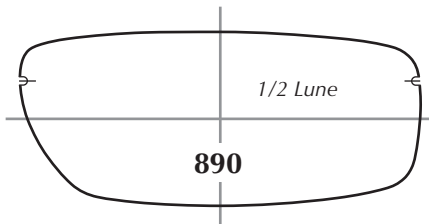
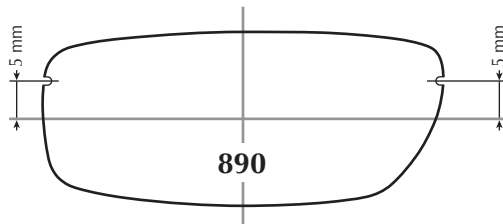

A	B	ED
56	40	63

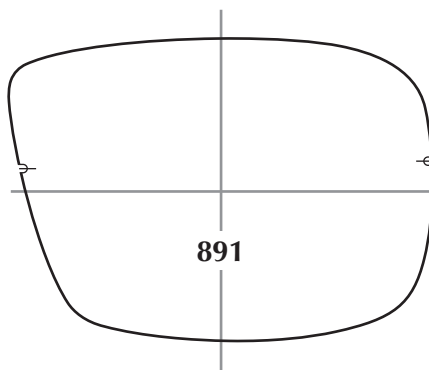
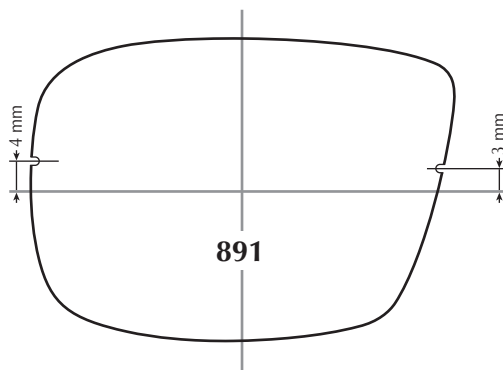

Toutes ces informations sont communiquées à titre indicatif et doivent être adaptées à la forme du nez du porteur.
All infos provided must be adapted to shape and size of the patient's nose.

⚠ Attention : certaines imprimantes peuvent ne pas reproduire ce document à l'échelle exacte.
Note: some printers may not duplicate this document at the correct scale.

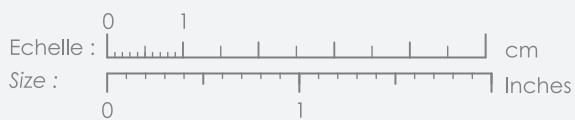

POCKET

Pont traditionnel
Traditional bridge

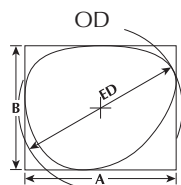

A	B	ED
56	46	61

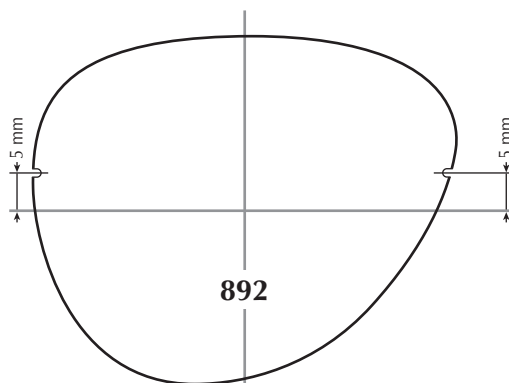

892

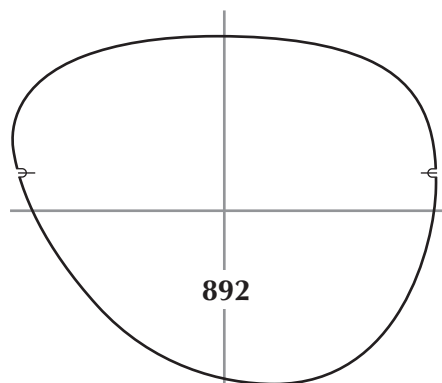

892

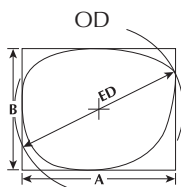

A	B	ED
56	46	63

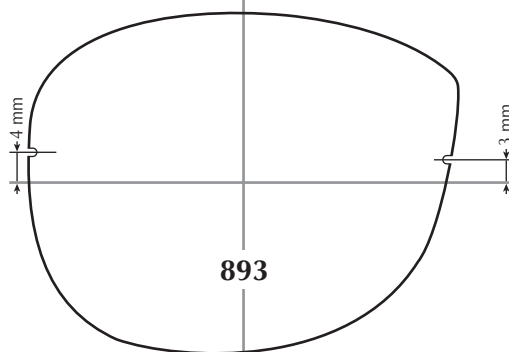

893

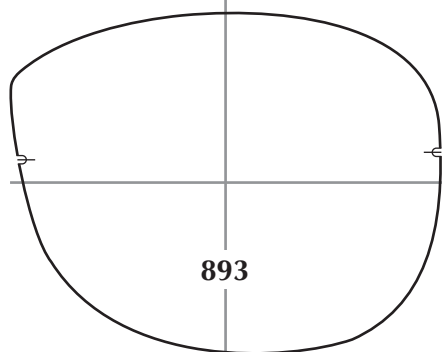

893

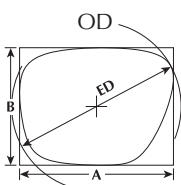

A	B	ED
57	43,5	63

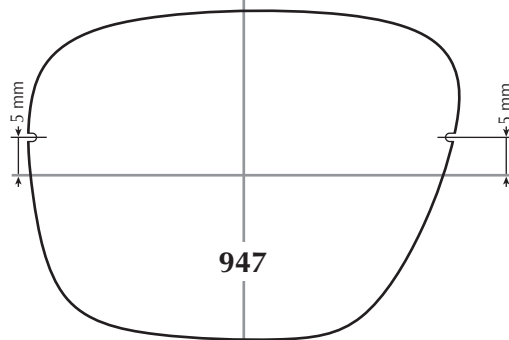

947

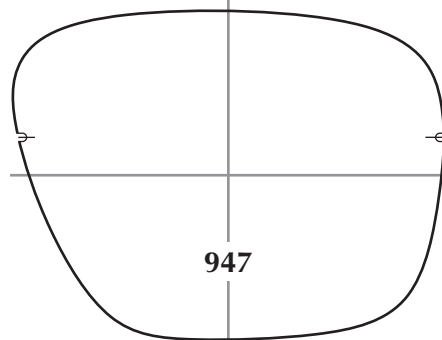

947

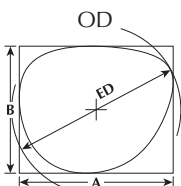

A	B	ED
57	47	63

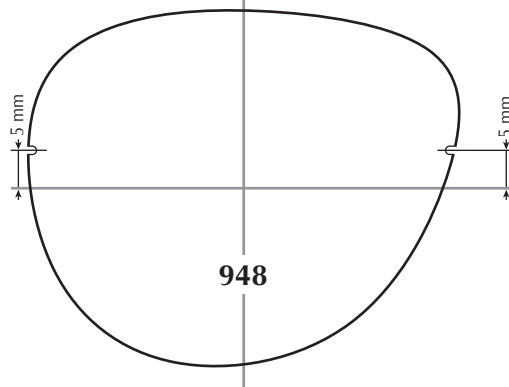

948

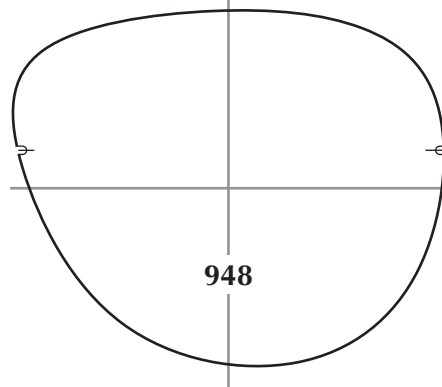

948

Toutes ces informations sont communiquées à titre indicatif et doivent être adaptées à la forme du nez du porteur.
All infos provided must be adapted to shape and size of the patient's nose.

⚠ Attention : certaines imprimantes peuvent ne pas reproduire ce document à l'échelle exacte.
Note: some printers may not duplicate this document at the correct scale.



POCKET

Pont traditionnel
Traditional bridge

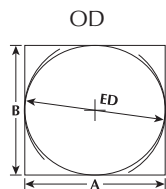

A	B	ED
52	48	52,5

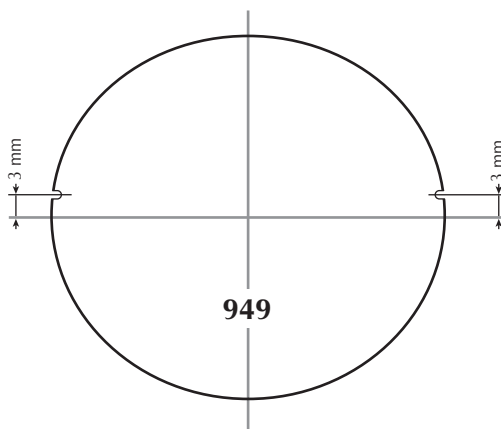

949

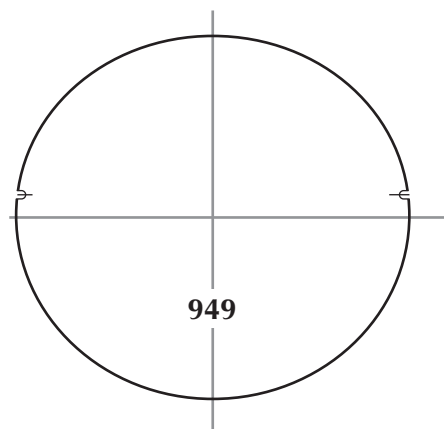

949

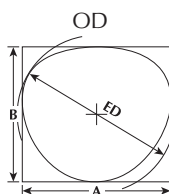

A	B	ED
55	50	58,5

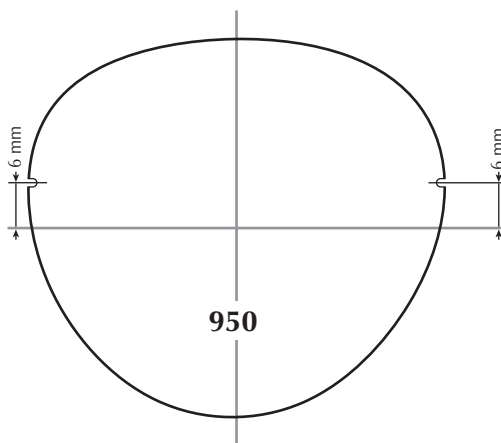

950

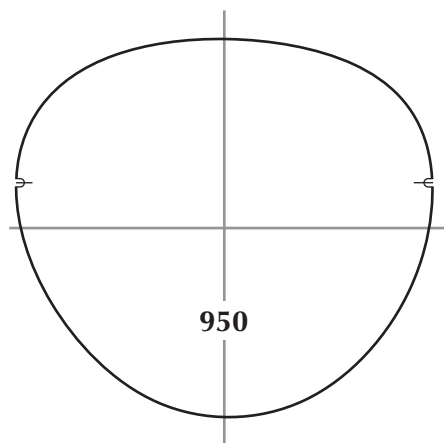

950

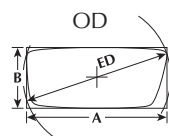

A	B	ED
52	22,5	55

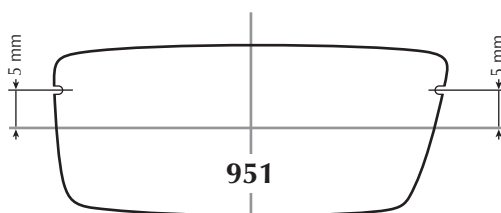

951

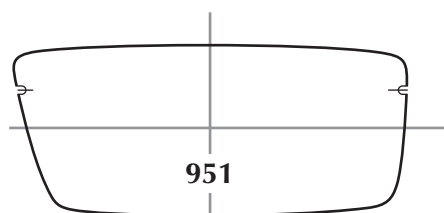

951

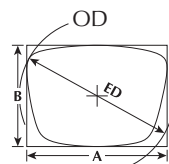

A	B	ED
52	37,5	58

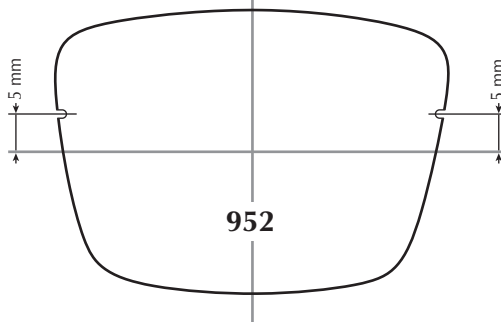

952

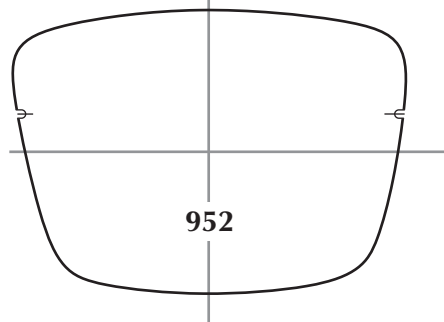

952

Toutes ces informations sont communiquées à titre indicatif et doivent être adaptées à la forme du nez du porteur.
All infos provided must be adapted to shape and size of the patient's nose.

⚠ Attention : certaines imprimantes peuvent ne pas reproduire ce document à l'échelle exacte.
Note: some printers may not duplicate this document at the correct scale.



POCKET

Pont traditionnel
Traditional bridge

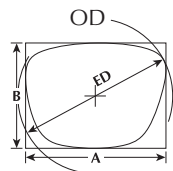

A	B	ED
52	39	58

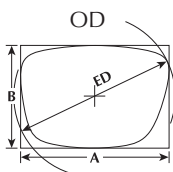
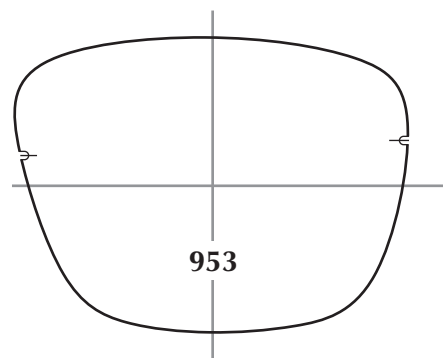
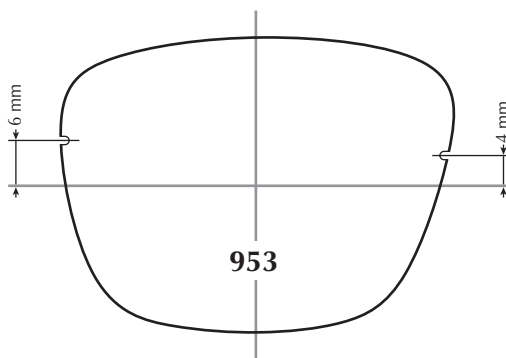

A	B	ED
55	38	60

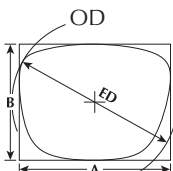
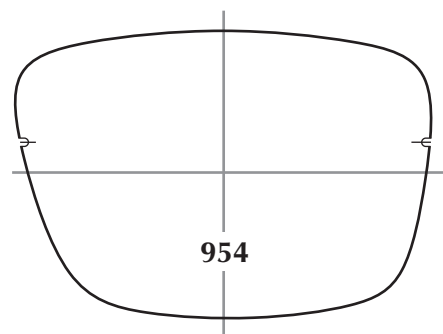
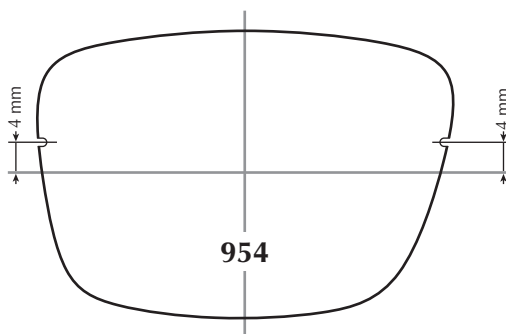

A	B	ED
56	43	62

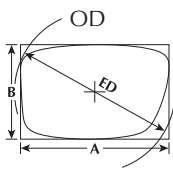
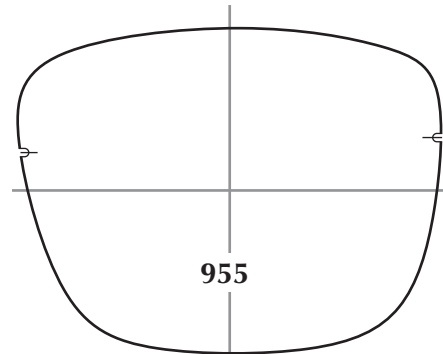
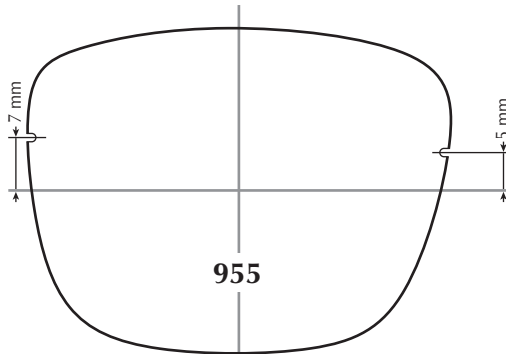

A	B	ED
55	35	60

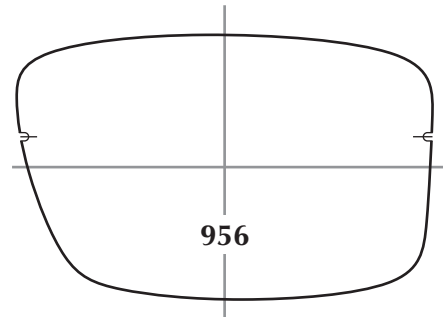
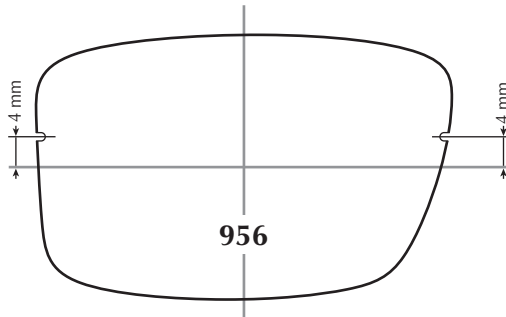

Toutes ces informations sont communiquées à titre indicatif et doivent être adaptées à la forme du nez du porteur.
All infos provided must be adapted to shape and size of the patient's nose.

⚠ Attention : certaines imprimantes peuvent ne pas reproduire ce document à l'échelle exacte.
Note: some printers may not duplicate this document at the correct scale.



POCKET

Pont traditionnel
Traditional bridge

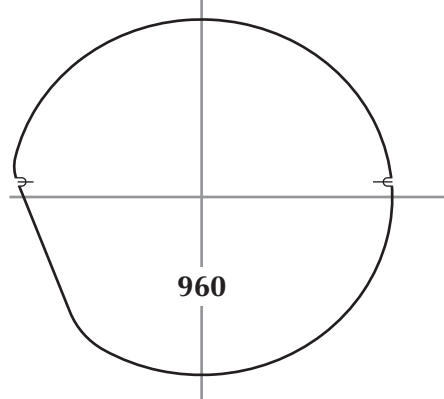
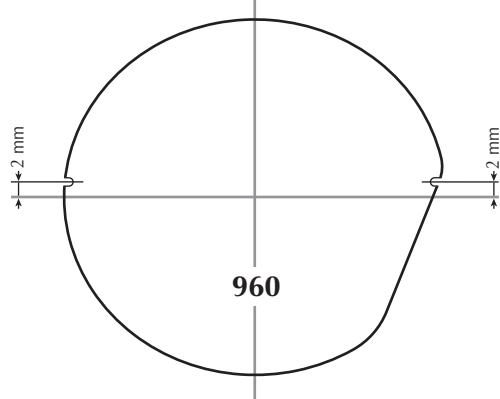
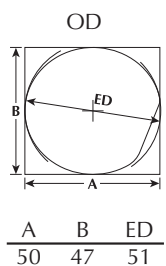
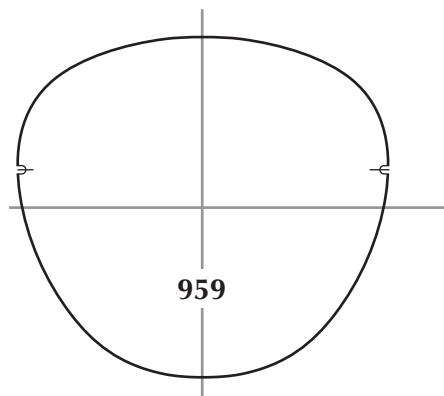
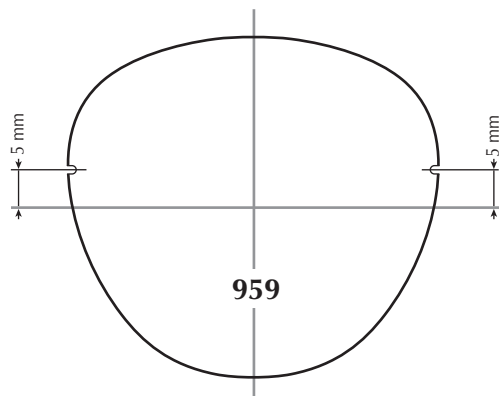
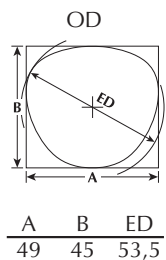
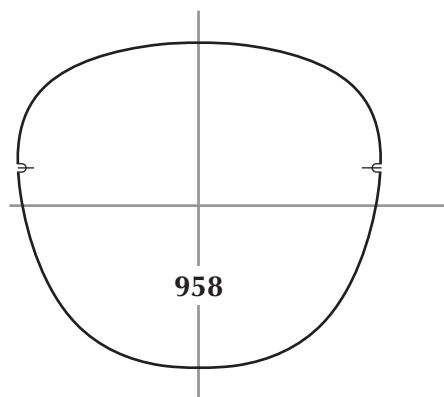
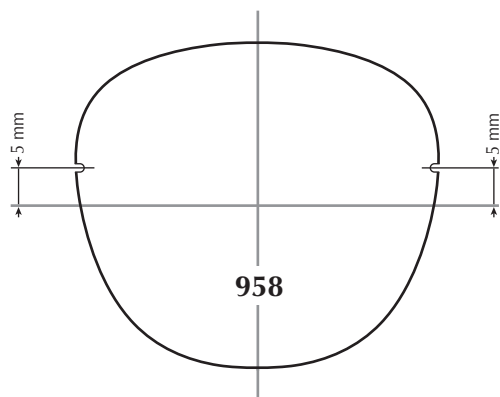
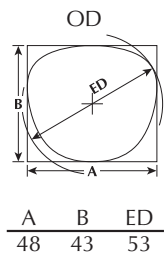
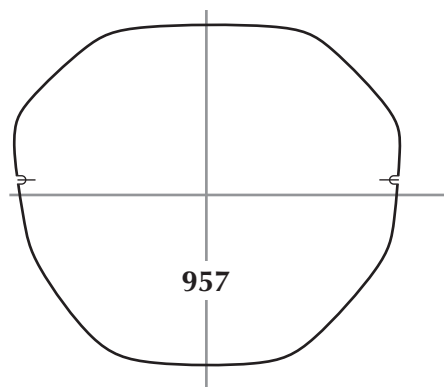
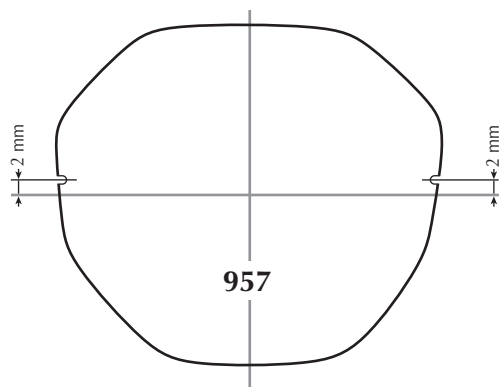
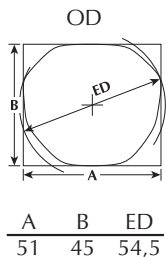

Toutes ces informations sont communiquées à titre indicatif et doivent être adaptées à la forme du nez du porteur.
All infos provided must be adapted to shape and size of the patient's nose.

⚠ Attention : certaines imprimantes peuvent ne pas reproduire ce document à l'échelle exacte.
Note: some printers may not duplicate this document at the correct scale.



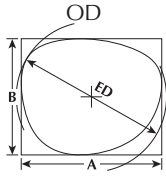

A	B	ED
52	43	56

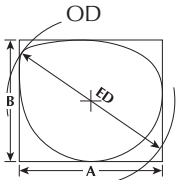

A	B	ED
53	45	63

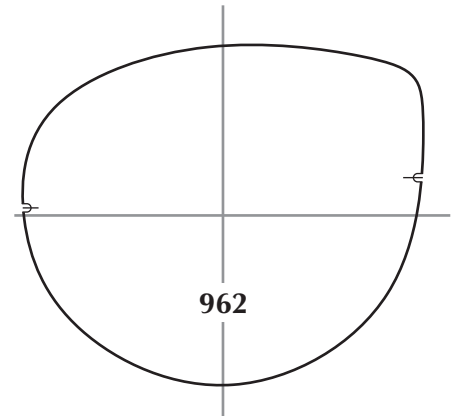
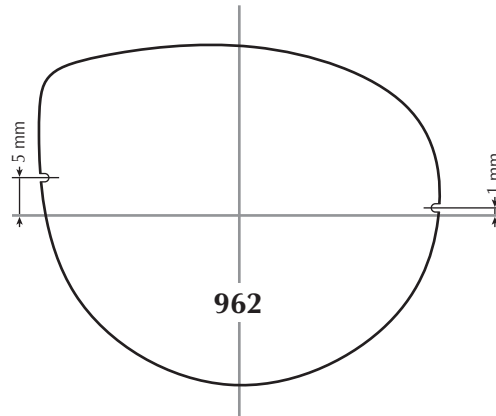
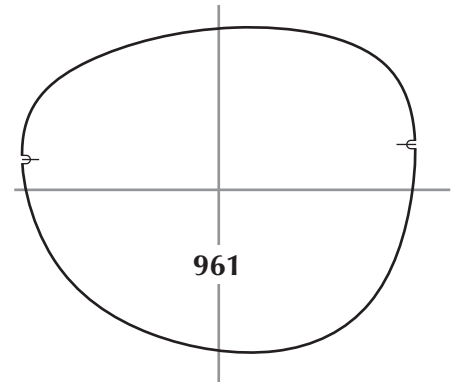
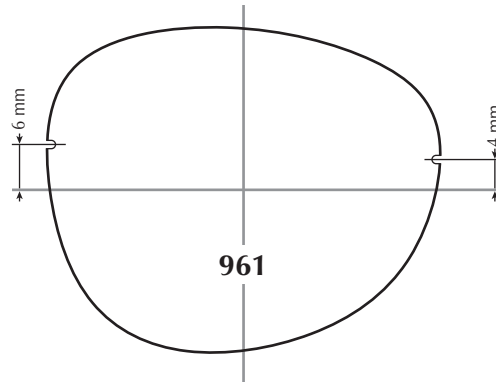

Toutes ces informations sont communiquées à titre indicatif et doivent être adaptées à la forme du nez du porteur.
 All infos provided must be adapted to shape and size of the patient's nose.

⚠ Attention : certaines imprimantes peuvent ne pas reproduire ce document à l'échelle exacte.
 Note: some printers may not duplicate this document at the correct scale.



FRANCE

Minima SAS
4, avenue Delage – 91310 Linas
Tél.: 01 69 01 03 03
Fax: 01 69 01 69 19
commande@minima.fr

Export

Tél.: +33 1 64 49 84 39
Fax: +33 1 64 49 39 92

DEUTSCHLAND

Minima GmbH
Lilienthalstr.8 – 10965 Berlin
Tel. 030-69817594
Fax. 030-69817596
deutschland@minima.fr

SUISSE

Minima SAS
Numéro gratuit : 0800 85 85 87
commande@minima.fr

PORTUGAL

Minima SAS
Número verde: 800 833 145
Fax: 800 833 144

BELGIQUE

Minima SAS
Numéro vert: 080074926
commande@minima.fr

UNITED KINGDOM

Minima SAS
Free phone number: 0808 234 0103
sales-uk@minima.fr

CONTACT